

ELEVATION A

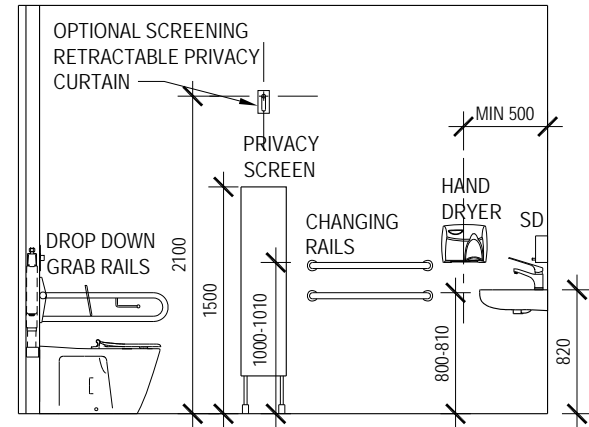

ELEVATION B

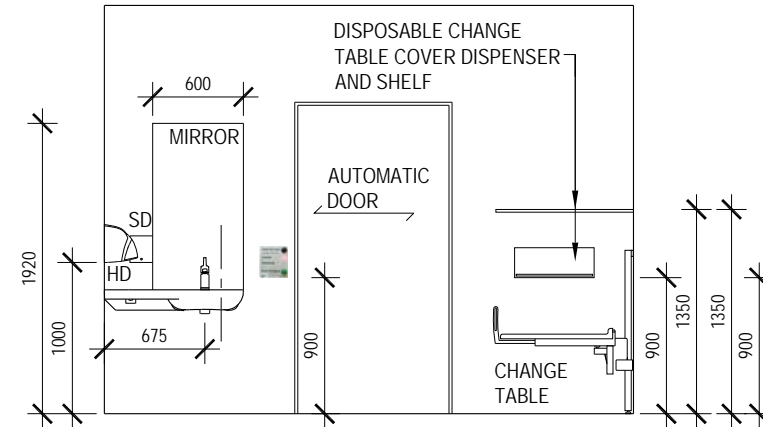

ELEVATION C

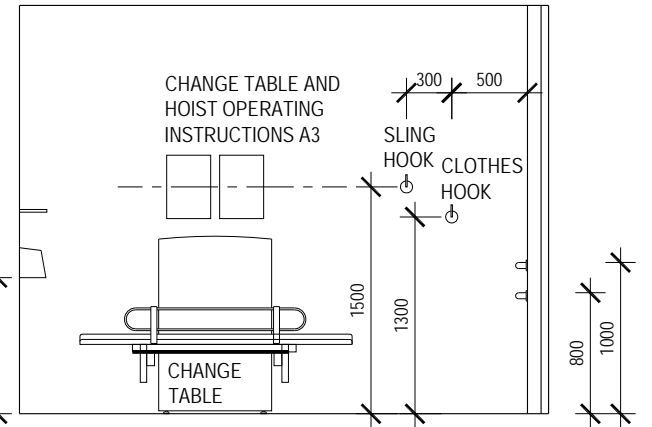

ELEVATION D

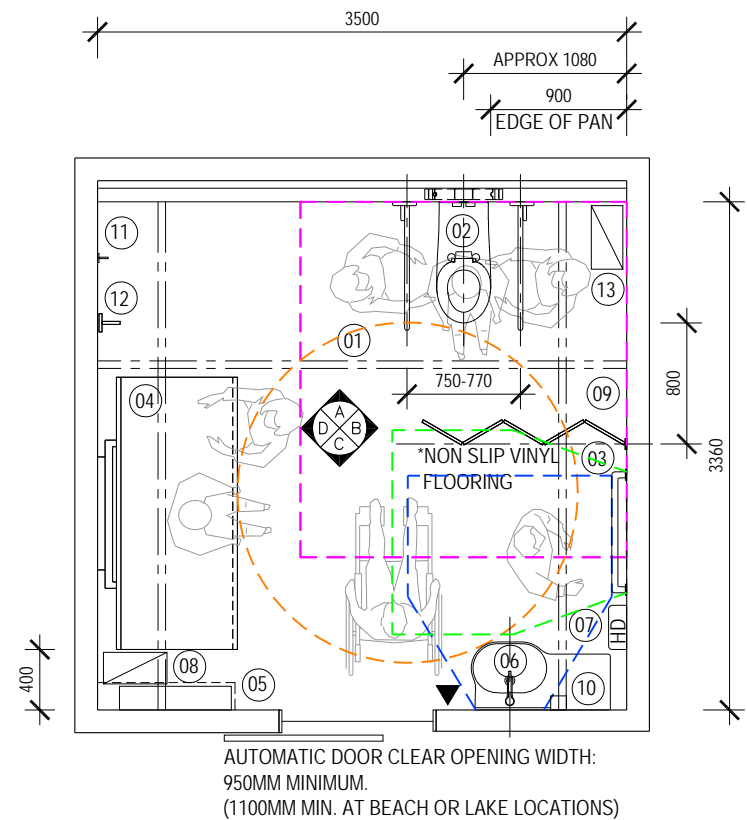

OPTION 1B
 SQUARE CONFIGURATION
 WITHOUT SHOWER

- 01 ROOM COVERAGE HOIST
- 02 ACCESSIBLE WC INCL BACKREST AND DROP DOWN GRAB RAILS
- 03 TWO 800MM LONG HORIZONTAL CHANGING RAILS AT 800MM AND 1000MM ABOVE FLOOR LEVEL
- 04 ADJUSTABLE HEIGHT CHANGE TABLE, 1800MM LONG WITH SIDE SAFETY RAIL
- 05 DISPOSABLE CHANGE TABLE COVER DISPENSER WITH SHELF OVER (OPTIONAL, REFER SPECIFICATION)
- 06 HAND WASH BASIN WITH INTEGRATED SHELF
- 07 HAND DRYER
- 08 INCONTINENCE PAD DISPOSAL BIN
- 09 RETRACTABLE PRIVACY SCREEN 1500MM LONG
- 10 SOAP DISPENSER
- 11 CLOTHES HOOK
- 12 LARGE SLING HOOK
- 13 SANITARY NAPKIN DISPOSAL BIN
- ▼ AUTOMATIC DOOR CONTROL

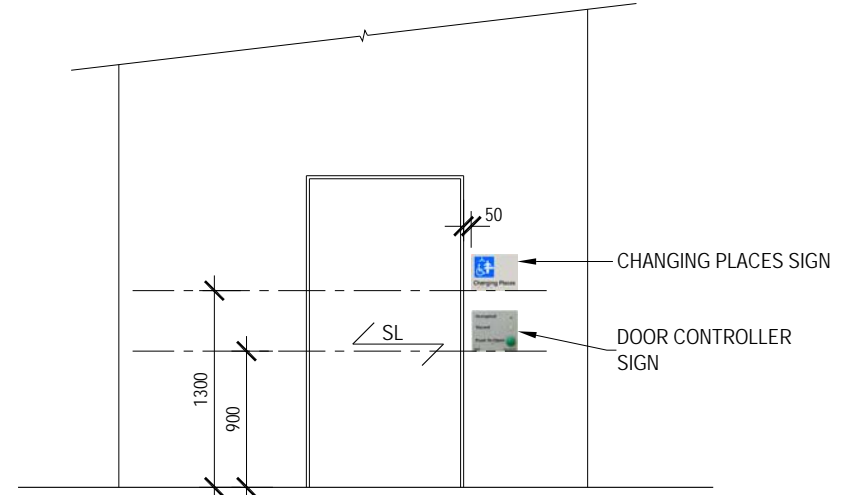

EXTERNAL DOOR
ELEVATION

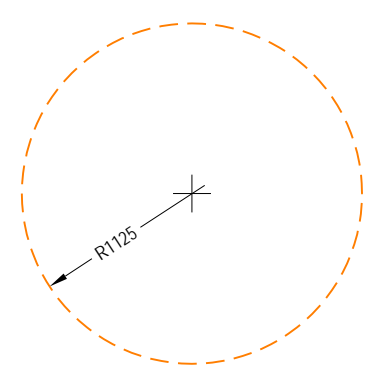

TURNING
 CIRCULATION SPACE

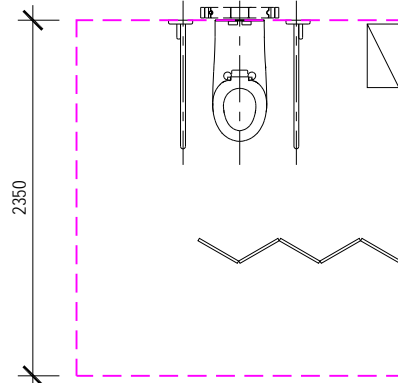

PAN
 CIRCULATION SPACE

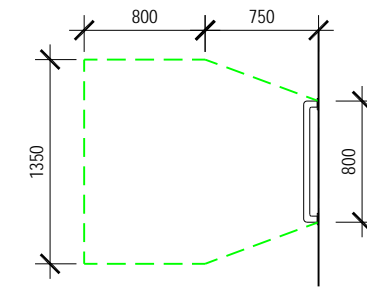

CHANGING RAILS
 CIRCULATION SPACE

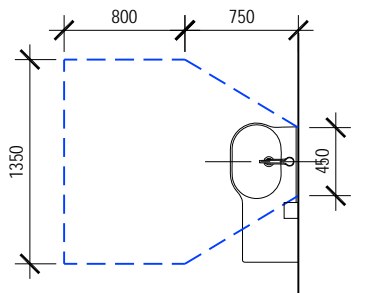

BASIN
 CIRCULATION SPACE

